

VGM300



VCR User's Guide

We bring good things to life.

Important Information

WARNING

To reduce the risk of fire or shock hazard, do not expose this VCR to rain or moisture.

WARNING

RISK OF ELECTRIC SHOCK DO NOT OPEN

TO REDUCE THE RISK OF ELECTRIC SHOCK, DO NOT REMOVE COVER (OR BACK). NO USER SERVICEABLE PARTS INSIDE. REFER SERVICING TO QUALIFIED SERVICE PERSONNEL.

 This symbol indicates "dangerous voltage" inside the product that presents a risk of electric shock or personal injury.

 This symbol indicates important instructions accompanying the product.

Cautions



CAUTIONS: To reduce the risk of electric shock, fully insert plug into socket. Operate VCR only on 100-240 volts (+/- 10%), 50/60 Hz AC power.

- It is important that you read and follow the safety information and operating instructions.
- Insure that the main supply in your house complies with that indicated on the identification sticker located at the back of your appliance.
- Install the VCR horizontally, away from a source of heat (fireplace) or appliances creating strong magnetic or electric fields (engines).

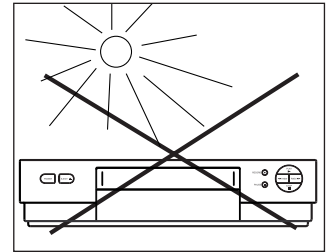
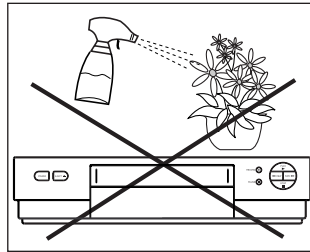
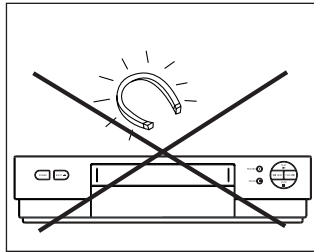

Follow the drawing below for leaving space around your VCR to insure proper ventilation.

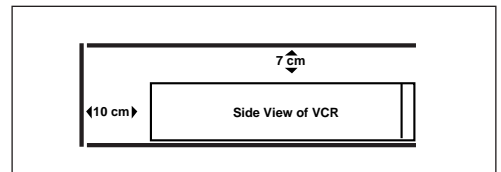
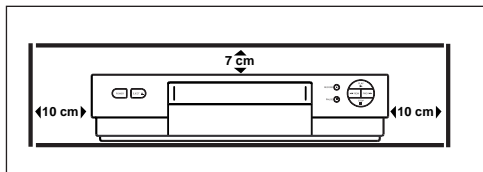

- If your VCR or a cassette has been stored in a very cold atmosphere for a certain amount of time, for example during transportation in the winter, wait approximately two hours before using your VCR.
- The openings located on the top and the bottom are for ventilation purposes. They should not be obstructed.
- In the case of lightning, it is recommended to disconnect the VCR from the external aerial.
- By design, this VCR is not for industrial use, but only for domestic operation.

Partial or global recording of copyright protected works made without explicit permission from the copyright holder are illegal.

Table of Contents

Important Information

Warnings	i
Cautions	i

Hooking Up the VCR

Choosing a Hookup	2
Antenna or Cable System Without a Cable Box	3
Cable System With Cable Box to Unscramble All Channels	4
Cable System With Cable Box to Unscramble Only Pay Channels	5
Connecting Two VCRs for Copying Tapes	6

Setting Up the VCR

Startup	
Check Accessories With VCR	7
Attach Power Cord to Back of VCR	7
Insert Batteries in Remote	7
Turn on the TV	7
Turn on the VCR	8
Select the VCR's Output Channel	8
Select the VCR's Video System	8
Select the Language/Escoje una Lengua/Seleccione o Idioma	8
Place Channels in the VCR's Memory	9
Add or Remove Channels from VCR's Memory	9
Use TV•VCR Button	10
Set the Time and Date	10

Using the Remote Control

Controlling a VCR	11
Component, VCR, and TV Buttons	12-13
Controlling a TV	14

Playing a Tape

Operating Instructions	
NTSC Video Playback Mode	15
Play a Tape	15

Using the Playback Features

Auto Head Cleaner	16
Pause for Stop-Action	16
Frame Advance	16
Slow Motion	17
Picture Search	17
Digital Auto Tracking	17
Manual Tracking	17
DISPLAY Button	18
Time Counter	18
Index Search	19
Zero Search	19
Commercial Scan	19

Recording a Program

Types of Recordings	20
Using the Recording Features	
Recording Speeds	20
Recording Pause	20
Basic Recording – Operating Instructions	21
Watch a TV Channel While VCR is Recording a Different Channel	21
Recording While You're Away	
Timer Recording	22
Select Cable Box or Satellite Receiver Channel	23
Check or Clear a Timer Recording	23
Timer Recording From the VCR's Line Input	23
One Touch Recording	24
Using Two VCRs for Copying and Editing Tapes	25
Using Dual Remote with AutoEdit	25

References

Location of Controls	
Front Panel	26
Back Panel	27
Display Panel	27-28
Specifications	29
Cleaning the VCR	29
Trouble Checks	30-31
Index	32-33

Choosing a Hookup

The hookups on pages 3 through 7 are divided into two hookup types: Basic (A) and Advanced (B).

The Basic hookup shows the backs of TVs that have only an antenna/cable connection. It is the easier of the two and additional accessories may not be needed.

The Advanced hookup shows the VCR hooked up to a monitor/receiver (TV with audio and video jacks). This type of connection may improve the picture quality as well as convenience of operation.

Answer the questions to choose the hookup for your VCR.

1. How do you receive your TV signals?

Choose one answer from below.

- A. Outside antenna – Turn to page 3.
- B. Rabbit ears (set-top) and/or bow tie antenna – Turn to page 3.
- C. Cable System – Go to question 2.

2. What type of Cable-TV system* do you have?

Choose one answer from below.

- A. Cable without a box – Turn to page 3.
- B. Cable box to unscramble all the channels – Turn to page 4.
- C. Cable box to unscramble only pay channels, such as HBO, Showtime, Cinemax, etc. – Turn to page 5.

*You may need to contact your local cable company for assistance.

Optional Hookups

How to hook up two VCRs for copying tapes?

- A. Select a hookup by answering the questions above.
- B. Then modify the connections as shown on page 6.

Antenna or Cable System Without a Cable Box

A. Basic hookup.

Use this hookup for a simple connection which requires fewer accessories.

1. Connect as shown.

This connection may require additional accessories not provided.

2. Plug in power cords of VCR and TV.

3. Continue to page 7.

Tune the TV to channel 3 to view the VCR.

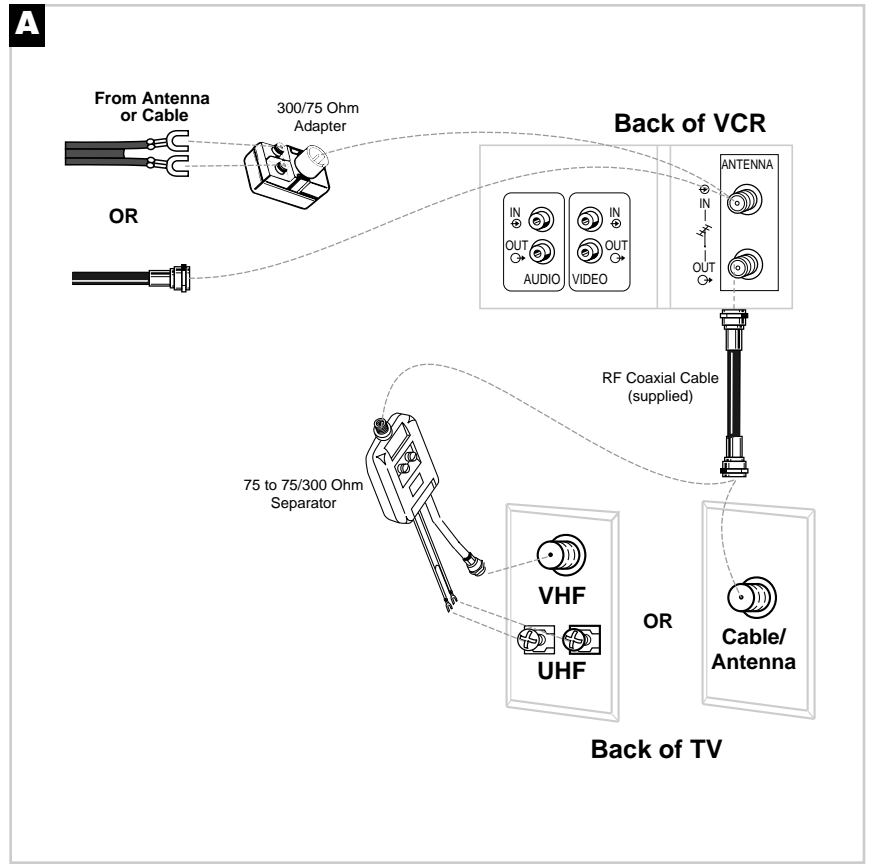

B. Advanced hookup.

Use this hookup for slightly improved picture quality and more convenient operation — use of TV•VCR button not required.

1. Connect as shown.

This connection requires additional accessories not provided.

If your TV is stereo, you may need a Y-adapter to hear sound from both channels.

2. Plug in power cords of VCR and TV.

3. Continue to page 7.

Tune the TV to its video input to watch the VCR.

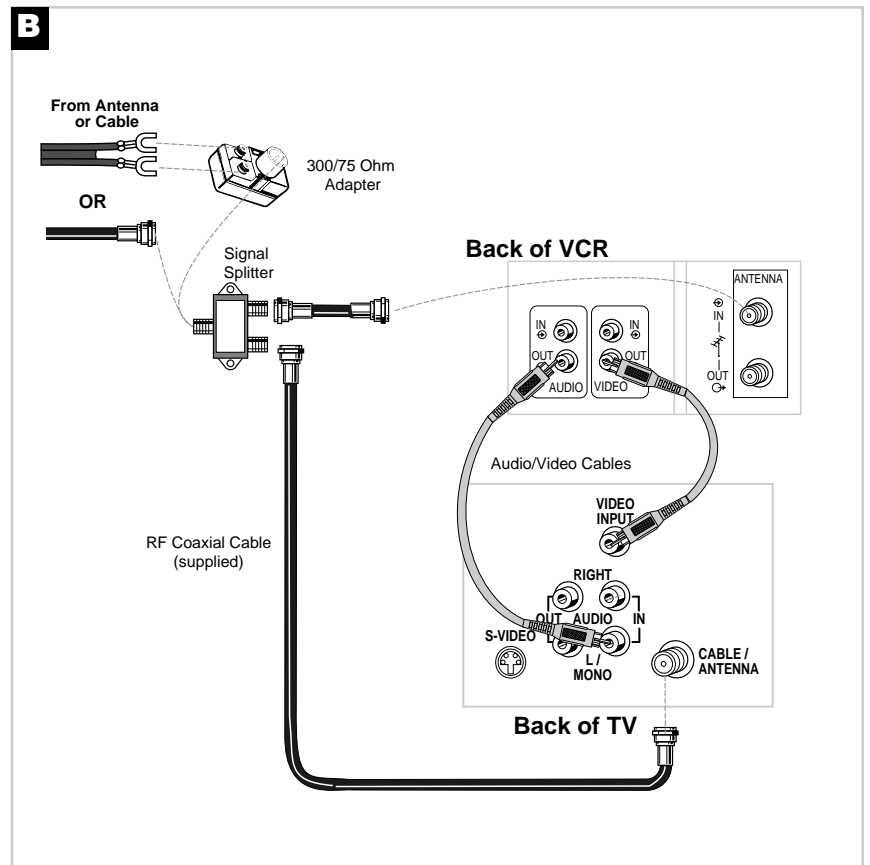

Cable System With Cable Box to Unscramble All Channels

A. Basic hookup.

Use this hookup for a simple connection which requires fewer accessories.

1. Connect as shown.

This connection may require additional accessories not provided.

2. Plug in power cords of VCR, TV, and cable box.

3. Continue to page 7.

Tune the TV to channel 3 to view the VCR.

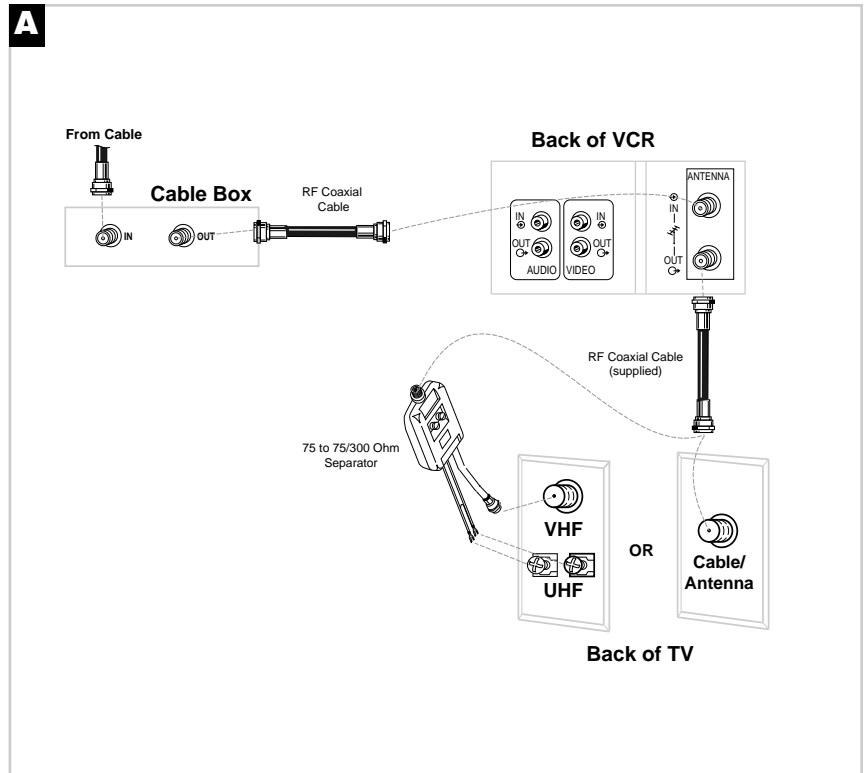

B. Advanced hookup.

Use this hookup for slightly improved picture quality and more convenient operation — use of TV•VCR button not required.

1. Connect as shown.

This connection requires additional accessories not provided.

If your TV is stereo, you may need a Y-adaptor to hear sound from both channels.

2. Plug in power cords of VCR, TV, and cable box.

3. Continue to page 7.

Tune the TV to its video input to watch the VCR.

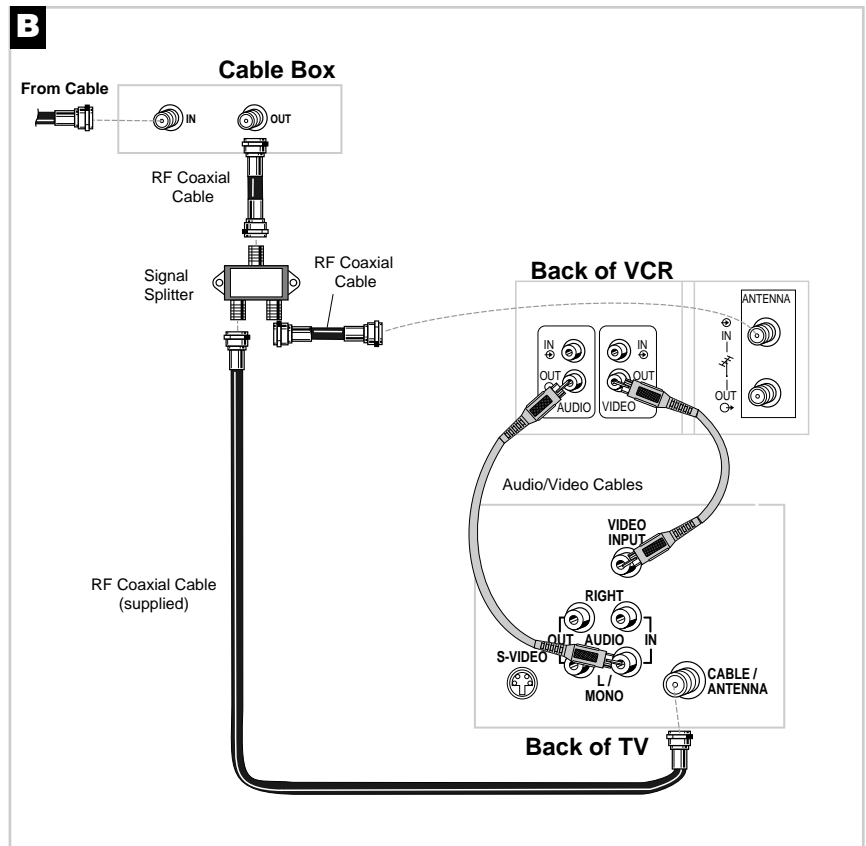

Caution: The unauthorized recording of television programs or other materials may infringe the rights of others.

Cable System With Cable Box to Unscramble Only Pay Channels

(such as HBO, Showtime, Pay-Per-View, etc.)

A. Basic hookup.

Use this hookup for a simple connection which requires fewer accessories.

1. Connect as shown.

This connection may require additional accessories not provided.

2. Plug in power cords of VCR, TV, and cable box.

3. Continue to page 7.

Tune the TV to channel 3 to view the VCR.

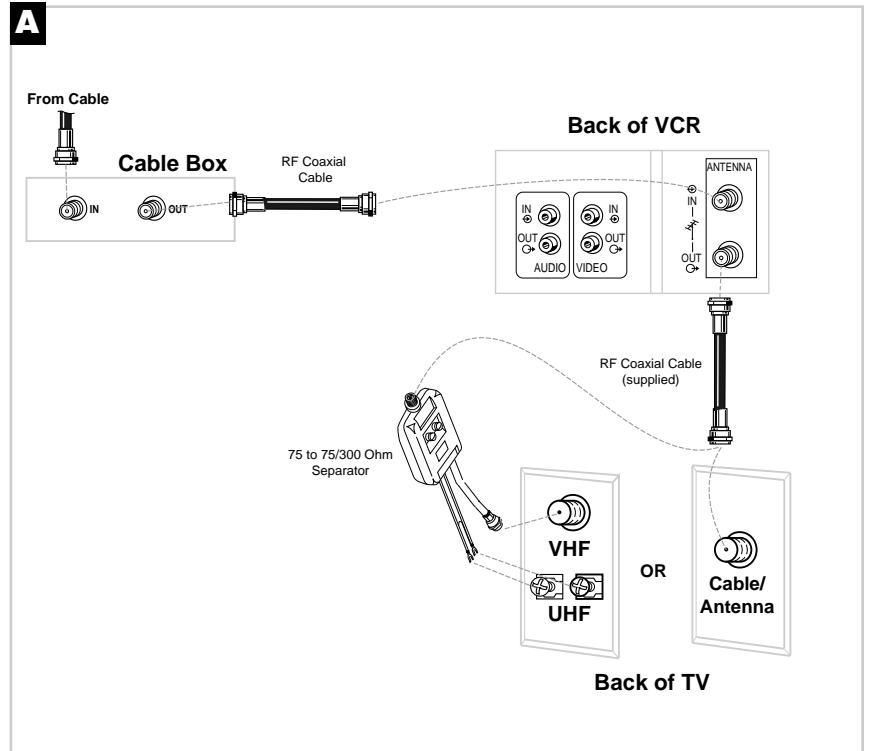

B. Advanced hookup.

Use this hookup for slightly improved picture quality and more convenient operation — use of TV•VCR button not required.

1. Connect as shown.

This connection requires additional accessories not provided.

If your TV is stereo, you may need a Y-adaptor to hear sound from both channels.

2. Plug in power cords of VCR, TV, and cable box.

3. Continue to page 7.

Tune the TV to its video input to watch the VCR. All pay channels are viewed through the VCR.

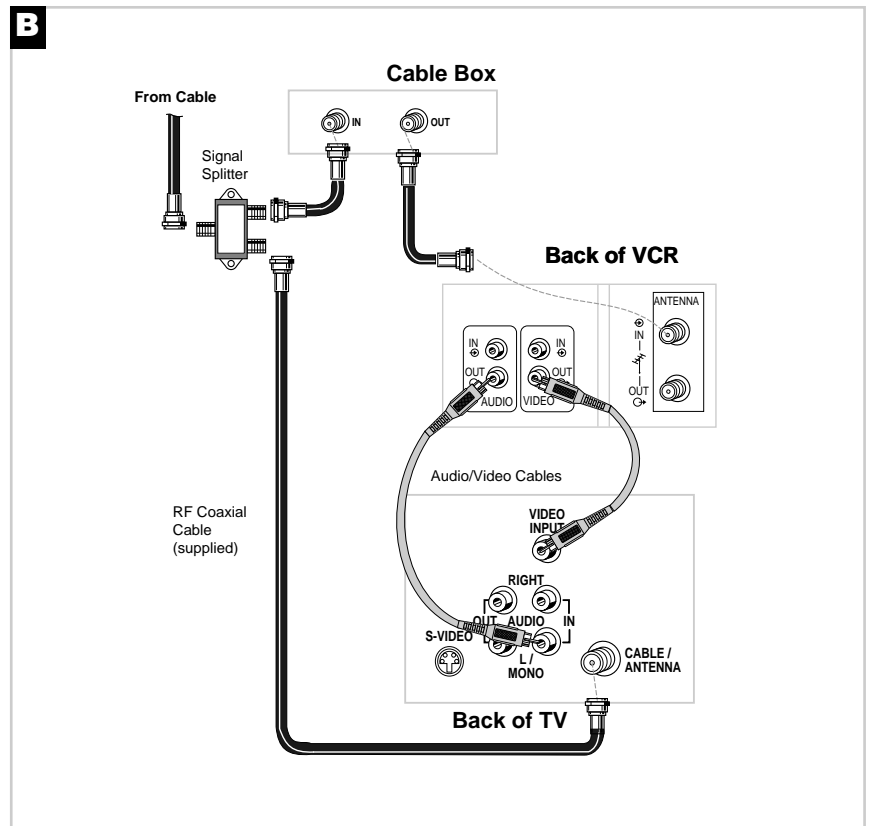

Connecting Two VCRs for Copying Tapes

Option A hookup.

Use this hookup for a simple connection which requires fewer accessories.

1. Select a hookup from pages 2 through 5 and then modify with this connection.
2. Set the VCR output channel to either channel 3 or 4. See page 8 for details.
You will tune the recording VCR to this channel to receive the signal from the playback VCR.
3. Connect as shown.
This connection may require additional accessories not provided.
4. Plug in power cords of VCRs and TV.
5. **Continue to page 7.**

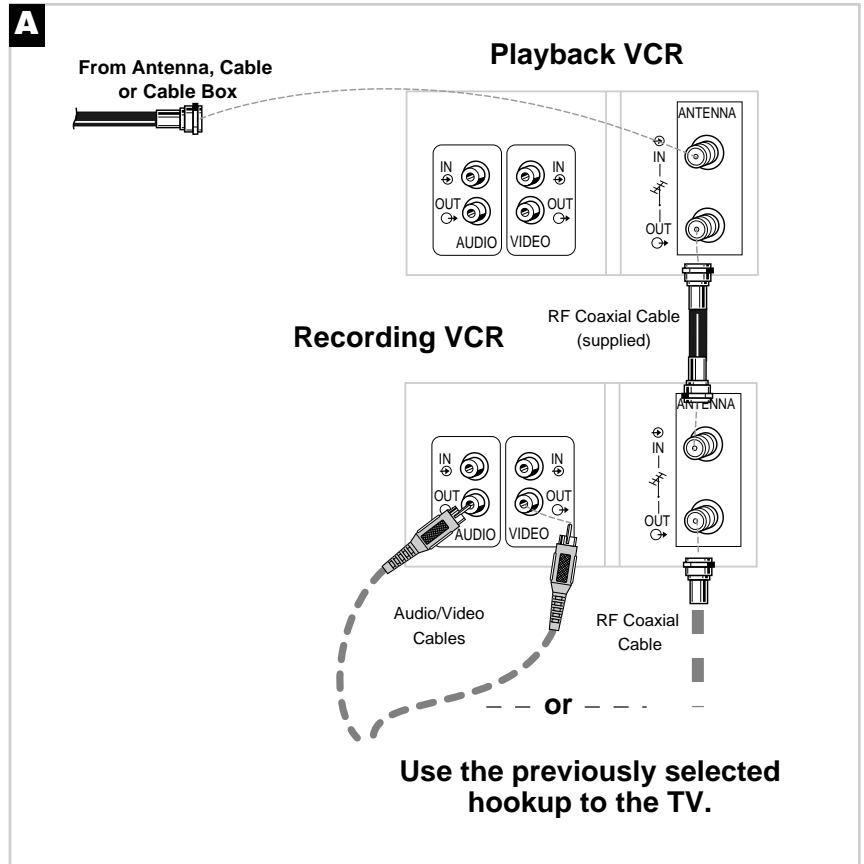

Option B hookup.

Use this hookup for slightly improved copy quality and more convenient operation — use of TV•VCR button not required.

1. Select a hookup from pages 2 through 5 and then modify with this connection.
2. Connect as shown.
This connection requires additional accessories not provided.
If your TV is stereo, you may need a Y-adaptor to hear sound from both channels.
3. Plug in power cords of VCRs and TV.
4. **Continue to page 7.**

Select the line (audio/video) input on the recording VCR to receive the signal from the playback VCR.

Caution: The unauthorized recording of television programs or other materials may infringe the rights of others.

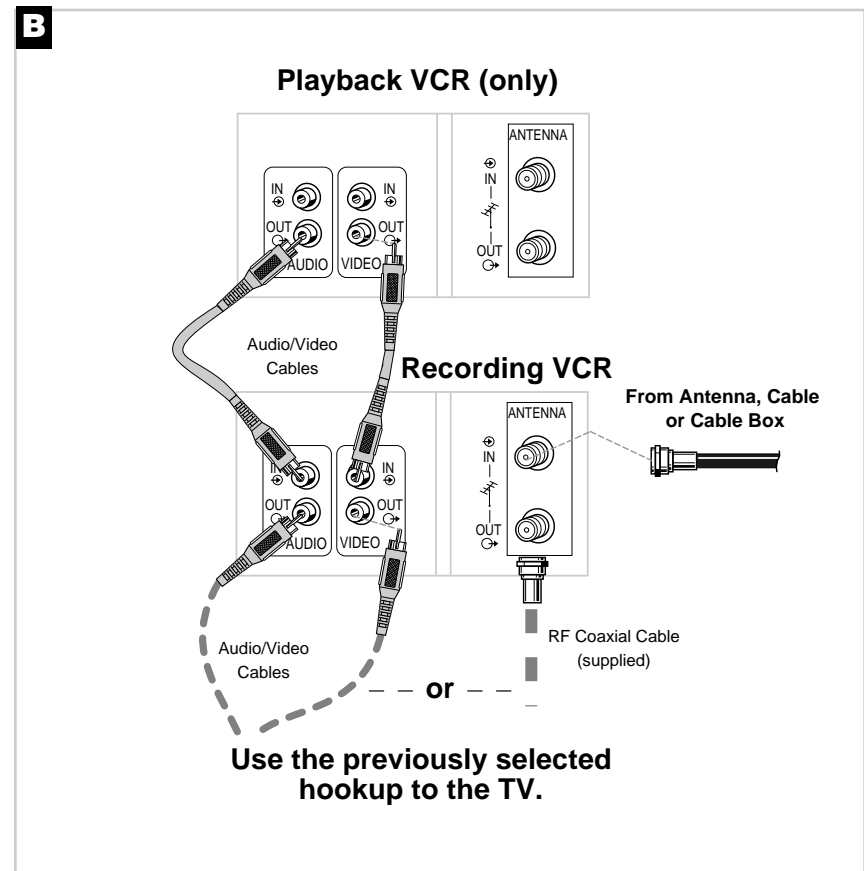

Startup

1. Check accessories with VCR.

Contact your dealer if any items are missing.

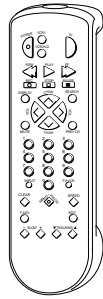

Remote
(Stock No. 221406)

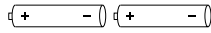

2 "AAA" Batteries



RF Coaxial Cable
(Stock No. 221407)

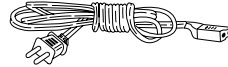

Power Cord
(Stock No. 221408)

2. Attach power cord to back of VCR.

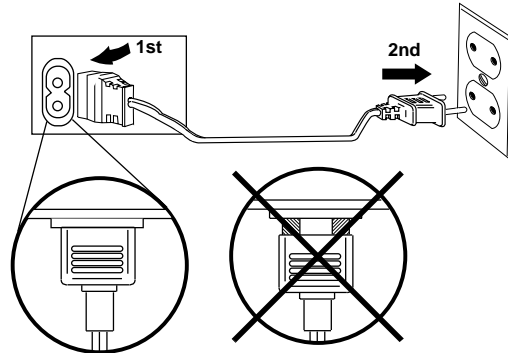

3. Insert batteries in remote.

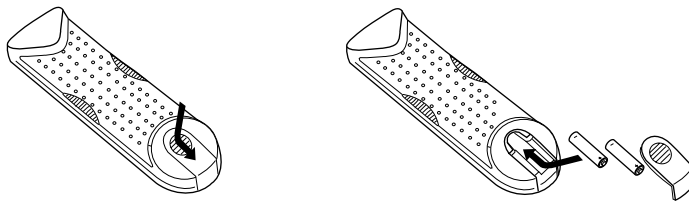

4. Turn on the TV.

- A. Turn on the TV.
- B. If you used one of the basic hookups, tune the TV to channel 3.
If you used one of the advanced hookups, tune the TV to the TV's video input. (See TV owner's manual for details.)

Startup

5. Turn on the VCR.

Press VCR1 on the remote.

6. Select the VCR's output channel.

- A. Press VCR1 on the remote.
- B. Press MENU•PROG on the remote to see the VCR MAIN MENU on the TV screen.
- C. Press 4 to display the PREFERENCES menu.
- D. Press 3 to select either 3 or 4 as the output channel for your VCR. This is the channel to which you tune your TV to see the picture from the VCR.
 - If you select Output Channel: 3, you will view the VCR's output on channel 3 of your TV.
 - If you select Output Channel: 4, you will view the VCR's output on channel 4 of your TV.

If you change the output channel, remember to tune your TV to the channel you selected (3 or 4) to watch the VCR.

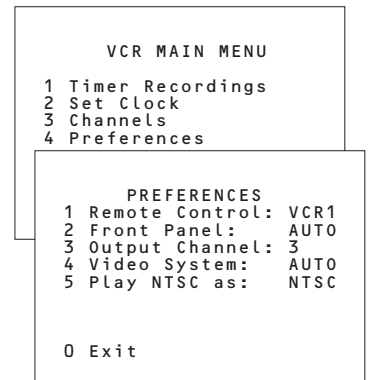

7. Select the VCR's video system.

- A. Press VCR1 on the remote.
- B. Press MENU•PROG on the remote to see the VCR MAIN MENU on the TV screen.
- C. Press 4 to display the PREFERENCES menu.
- D. Press 4 to select the type of video that is broadcast in your area.
 - Select Video System: AUTO to have the VCR automatically select the type of video.
 - Select Video System: PAL if PAL video is broadcast in your area.
 - Select Video System: NTSC if NTSC video is broadcast in your area.

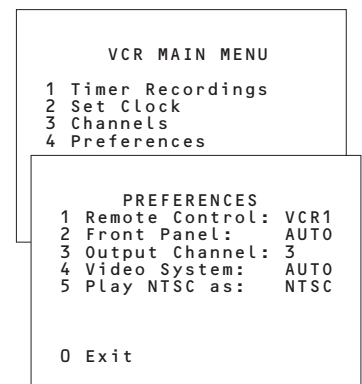

8. Select the language/Escoja una lengua/Selecione o idioma.

This feature lets you select English, Spanish, or Portuguese as the language for your on-screen menus.

- A. Press MENU•PROG on remote to see VCR MAIN MENU on the TV screen.
- B. Press 5 to display the LANGUAGE menu.
 - Press 1 to display the menus in English.
 - Press 2 to to display the menus in Spanish.
 - Press 3 to to display the menus in Portuguese.

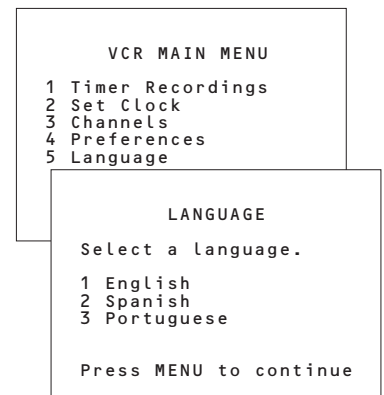

Startup

9. Place channels in the VCR's memory.

Channels 2 through 13 including line inputs (L1 and L2) are in the VCR's memory when you first turn it on. The VCR stops on these channels when you press CHAN up or down on the remote or CHANNEL up or down on the VCR. To get additional channels available on your antenna or cable system, you must use the Auto Channel Search feature of the VCR. If you ever change cable or antenna signals, you may need to auto channel search again. *See Cable Box Setup on page 23.*

- A. Press VCR1 to set remote to control VCR.
- B. Press MENU•PROG on the remote to see the VCR MAIN MENU on the TV screen.

If the menu does not appear on the TV screen:

- Press VCR1 and then press MENU•PROG.
- If you have used one of the basic hookups, make sure the TV is tuned to the same channel (3 or 4) as the Output Channel selected in the PREFERENCES menu.

Check VCR indicator in display panel — it should be on. Press TV•VCR to turn it on.

- If you have connected your VCR using one of the advanced hookups, tune your TV to its video input (refer to TV Owner's manual).
- Check the connections.

- C. Press 3 to select CHANNELS.
- D. Press 1 to begin Auto Channel Search.

Wait until the channel numbers stop changing. The TV will then tune to the lowest channel found. Press CHAN up or down on the remote or CHANNEL up or down on the VCR to select the active channels.

The VCR automatically selects ANTENNA or CABLE for the Signal Type feature in the CHANNELS menu. If you need to change the setting manually, press 3.

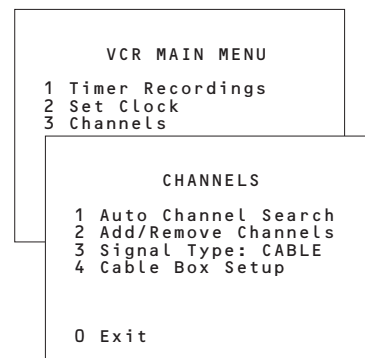

10. Add or remove channels from the VCR's memory.

You may want to add or remove channels if some of the channels are not active, have weak signals, or you do not want to watch them.

- A. Press VCR1 on the remote.
- B. Press MENU•PROG on the remote to see the VCR MAIN MENU on the TV screen.
- C. Press 3 to display the CHANNELS menu.
- D. Press 2 to display the ADD/REMOVE CHANNELS menu.
- E. Follow the directions on the screen.
- F. Add or remove more channels by entering channel numbers or using the CHAN up or down on the remote or CHANNEL up or down on the VCR.

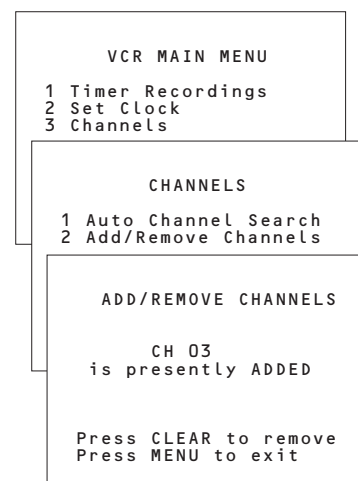

continued on next page

Startup

11. Use TV•VCR button.

Skip this step if you used one of the advanced hookups.

When using one of the basic hookups, the TV•VCR button lets you switch between the picture coming from the VCR or the picture from the TV channel. This button lets you record a program on the VCR while watching another channel on the TV. *Details are on page 21.*

The VCR will automatically switch the TV•VCR setting to VCR every time the VCR is turned on, a tape with the safety tab removed is inserted, or you press PLAY.

- A. Press VCR1 to set the remote to control the VCR.
- B. Press TV•VCR to see the picture from the VCR.
The VCR indicator lights in the display panel.
- C. Press CHAN up or down on the remote or CHANNEL up or down on the VCR to change channels on the VCR.
The channel number changes in the display panel.
- D. Press TV•VCR to see the TV channels.
The VCR indicator does not light in the display panel.
Change channels using the TV's remote.
- E. Return the TV to the VCR viewing channel (3 or 4) — the same Output Channel you selected in step 6.
- F. Press VCR1, then TV•VCR to switch back to the picture from the VCR.

12. Set the time and date.

When you first turn on the VCR, --:-- appears in the clock area of the VCR's display panel.

- A. Press MENU•PROG on remote to see VCR MAIN MENU on the TV screen.
- B. Press 2 to display SET CLOCK.
- C. Enter the time and date with the number buttons on the remote.
 - Press 0 before single-digit numbers.
Example: press 0, then 5, then 0, then 7 for a time of 5:07. Press 1 for AM or 2 for PM.
 - Press CLEAR on the remote to change incorrect entries.
- D. Press MENU•PROG to remove the SET CLOCK menu from the TV screen and start the clock.
- E. Press 0 to exit the menu system.

The time and date appear on the TV screen whenever you press DISPLAY, and the time appears in the display panel.

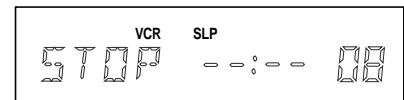

Controlling a VCR

The VCR's remote controls two compatible GE, RCA, or ProScan VCRs with the VCR1 and VCR2•LD buttons. Most compatible VCRs automatically respond to VCR1 without being programmed. If you own two compatible VCRs, test them to see if VCR1 turns on both VCRs. If it does, then you may want to program this VCR to respond to the VCR2•LD button on the remote.

Program the VCR for Remote Control

Set the Remote Control feature of the VCR to the VCR1 or VCR2•LD position. The remote then controls the VCR with either the VCR1 or VCR2•LD button — whichever position you select in the menu.

1. Press MENU•PROG to display the VCR MAIN MENU.
2. Press 4 to display PREFERENCES.
3. Press 1 to activate the Remote Control feature.
4. Press VCR1 or VCR2•LD to change the setting and program this VCR to respond to the VCR1 or VCR2•LD button — whichever you select.

Important Reminder: Remember you must press VCR1 or VCR2•LD on the remote — whichever you selected in the menu — before the remote will operate this VCR.

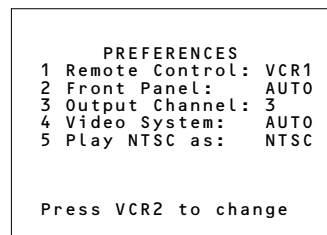
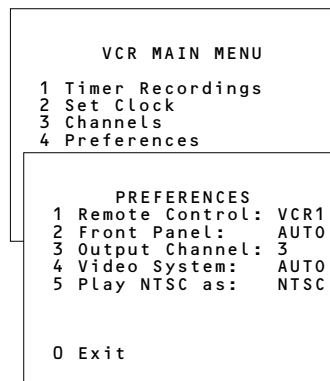

Buttons

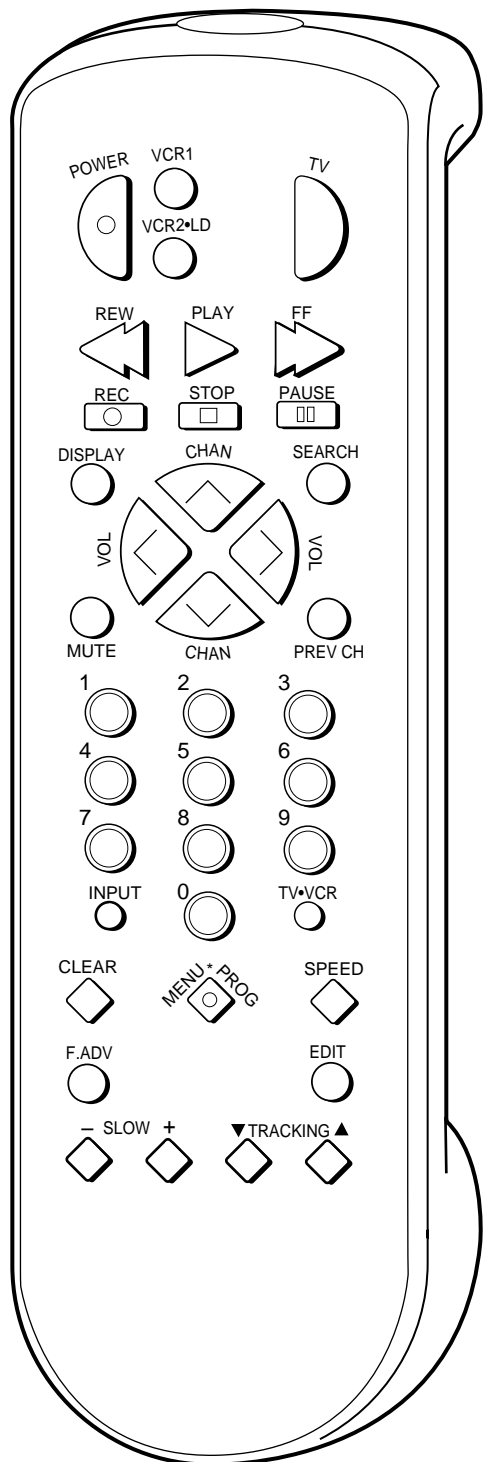

Component Buttons

Press one of the buttons to set the remote to operate that component.

TV

Turns on a compatible GE, RCA, or ProScan TV and sets the remote to control the TV.

Used with POWER button to turn on another brand of TV, other than GE, when the remote is programmed to control that TV. (See page 14.)

VCR1

Turns on a compatible GE, RCA, or ProScan VCR and sets remote to control the VCR.

VCR2•LD

Turns on a compatible GE, RCA, or ProScan VCR and sets remote to control VCR when it has been setup. (See page 11.)

Used with POWER button to turn on compatible RCA or ProScan LaserDisc player.

VCR Function Buttons

Press VCR1 (VCR2•LD) to set remote to control the VCR to use the function buttons.

CHAN Up or Down

Selects next higher or lower channel in the VCR's channel memory.

CLEAR

Resets time counter to 0:00:00.

Allows you to change entries when setting the clock or VCR for a timer recording.

DISPLAY

Shows VCR operating displays on the TV screen.

Displays the time counter.

EDIT

Signals two properly connected VCRs to begin copying a tape. See page 25.

F.ADV (Frame Advance)

Lets you view one frame with each press of the button when tape is in stop-action pause.

FF (Fast Forward)

Fast forwards the tape when the VCR is stopped.

Searches the picture in forward motion during playback.

INPUT

Turns the line input on or off. L1 or L2 appears in VCR's display panel and VIDEO1 or VIDEO2 appears on TV screen. Line input refers to the signal coming from the audio/video input jacks on the back (L1) or front (L2) of the VCR.

MENU•PROG

Displays the VCR MAIN MENU on the TV screen.

Removes a menu from the screen.

Numbers (0 through 9)

Select a channel up to 99 by pressing two numbers.

Select a cable channel over 99 by pressing and holding 1 until 1-- appears on the screen. Then press the other two numbers.

PAUSE

Pauses action for viewing during playback.

Pauses recording to prevent recording of unwanted scenes.

Buttons

VCR Function Buttons (continued)

PLAY

Plays a tape.

POWER

Turns off VCR when remote is set to control the VCR.

PREV CH (Previous Channel)

Switches between two channels. Select one channel and then use the number buttons to select the other channel. Press PREV CH to switch between the two channels.

REC (Record)

Starts VCR recording.

Used for one touch recording (OTR). *See page 24.*

REW (Rewind)

Rewinds the tape when the VCR is stopped.

Searches the picture in reverse motion during playback.

SEARCH

Displays INDEX and ZERO SEARCH menus on the TV screen.

Advances tape 60 or 120 seconds during playback.

SLOW - / +

Used for slow-motion forward playback.

SPEED (Tape Speed)

Selects a recording speed (SP, LP, SLP).

STOP

Stops the normal functions such as record, playback, rewind, fast forward, and pause of the VCR.

TRACKING Up or Down

Lets you manually reduce the streaks that may appear on the picture during play or pause.

Reduces picture "jitter" during stop-action playback.

TV•VCR

Switches the picture signal so that it either comes from the VCR or the TV channel. *See page 10.*

TV Function Buttons

Press the TV button to set remote to control a compatible TV. Some buttons may not work with the TV.

CHANNEL Up or Down

Selects next higher or lower channel in the TV's channel memory when remote is set to control a TV.

CLEAR

Removes menus or status displays from the screen.

DISPLAY

Shows the status displays on the screen.

Removes menus or displays from the screen.

MUTE

Turns the TV sound on or off.

Numbers (0 through 9)

Select a channel up to 99 by pressing two numbers.

Select a cable channel over 99 by pressing and holding 1 until 1-- appears on the screen. Then press the other two numbers.

POWER

Turns off a compatible TV when remote is set to control TV.

Used with TV button to turn on a compatible TV, other than GE, when the remote is programmed to control that TV. *See page 14.*

PREV CH (Previous Channel)

Switches between two channels. Select one channel and then use the number buttons to select the other channel. Press PREV CH to switch between the two channels.

SLOW + and -

Used with the TV's menus to select and adjust features.

VOL (Volume) Up or Down

Raises and lowers sound of TV.

Controlling a TV

The VCR's remote is preprogrammed to control the basic functions of a compatible GE, RCA, or ProScan TV. The remote can also be set up to control other manufacturer's brands. To program the remote, enter remote code numbers that correspond to your brand.

Program the Remote for a TV

1. Turn on the TV.
2. Point the VCR remote at the TV.
3. Hold the TV button and press two number buttons to enter the code for your brand. If the TV changes channels when you press CHAN up or down, setup is complete.
4. Release the buttons.
5. Repeat steps 2 – 4 with a different code if the first one does not work.

Helpful Hint: Notice the difference between the TV and VCR on-screen displays. This is one way to tell if the remote is set to control the VCR or the TV.

Brand *	Remote Button	Brand *	Remote Button
Akai	03	NAD	07
AOC	06	NEC	06
Candle	06	Panasonic	04,11
Citizen	06	Philco	04,06
Colortyme	06	Philips	03,04,06
Concerto	06	Pioneer	06
Curtis Mathes	01,06	Portland	06
Daewoo	06	ProScan	01
Daytron	06	Proton	06
Electrohome	06	Quasar	11
Emerson	06	Radio Shack	01,05,13
Envision	05,06	RCA	01,06
Fisher	05,08	Realistic	05
GE	00,01,06,11	Sampo	06
Goldstar	06	Samsung	06,09
Hallmark	06	Sanyo	05,08
Hitachi	06	Sears	01,05,06,07,08,10,
Infinity	04		
J C Penney	00,01,06,09	Sharp	06,13
JBL	04	Sony	03
Jensen	06	Soundesign	06
JVC	10,11	Sylvania	04,06
Kawasho	03,06	Technics	11
Kenwood	06	Techwood	06
Loewe	04	Teknika	06
Luxman	06	TMK	06
LXI	04,05,07	Toshiba	05,07,09
Magnavox	04,06	Universal	00
Marantz	04	Victor	10
Marantz	04,06,12	Wards	00,01,04,06,
MGA	06		13
Mitsubishi	06,12	Zenith	02
MTC	06		

* The remote may not be able to control every model TV of the brands listed.

Operate the TV

After you have set up your remote to control your TV, test the TV buttons to see which ones operate your TV.

1. Point the remote at the TV and press TV.
2. If TV does not turn on in step 1, press TV and then POWER.
3. Use the "TV Function Buttons" as described on page 13.

Operating Instructions

NTSC Video Playback Mode

You can select the type of playback for tapes recorded in NTSC.

1. Press MENU•PROG on the remote to see the VCR MAIN MENU on the TV screen.
2. Press 4 to display the PREFERENCES menu.
3. Press 5 to select NTSC or PAL playback.
 - Select Play NTSC as: PAL to have the tape play back in PAL.
 - Select Play NTSC as: NTSC to have the tape play back in NTSC.

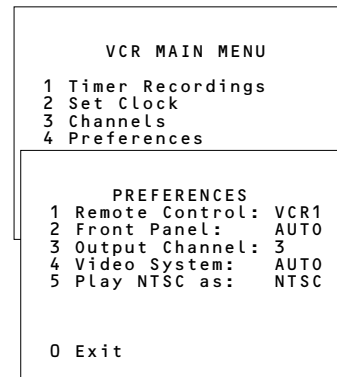

Play a Tape

1. Turn on the TV and tune it to channel 3, 4, or TV's video input to see the picture from the VCR.
2. Insert a tape in the VCR.

VCR automatically turns on. The cassette-in  indicator lights and the VCR indicator lights. The tape automatically begins playback if the safety tab on the cassette has been removed.

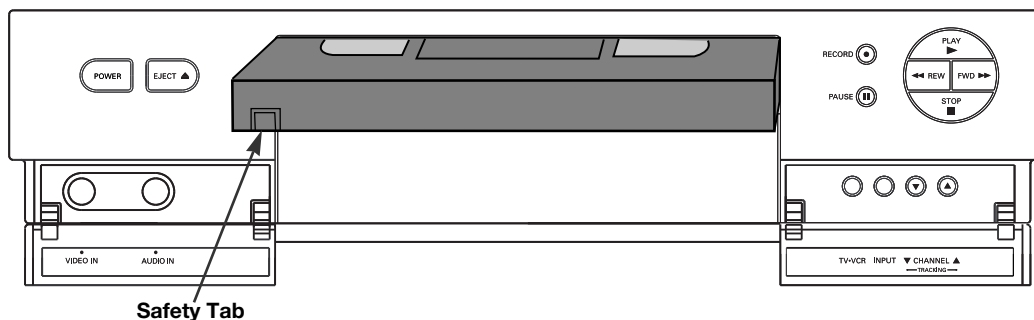

3. Press PLAY, if necessary. PLAY appears in the VCR's display panel.
4. Press TRACKING up or down to remove any streaks from the picture, if necessary. *Details are on page 17.*
5. Press STOP.
6. Press REW.

The VCR will automatically rewind the tape if it reaches the end of the tape during playback. While rewinding, you can press POWER and the VCR will turn off after rewinding.
7. Press EJECT on the VCR to eject the tape once it is completely rewound.

Using the Playback Features

Auto Head Cleaner

The VCR has an automatic head cleaner that minimizes the need for professional head cleaning.

Pause for Stop Action

This feature stops the tape in action and allows you to examine the details of the scene. Stop action works best for tapes recorded in the SP and SLP speed.

1. Press PAUSE during playback to stop the action.
STILL appears in the VCR's display panel.
2. Press TRACKING up or down to reduce any jittering of the picture.
3. Press PAUSE or PLAY to return to playback.
The VCR will automatically switch from stop-action playback to stop after a few minutes.

Frame Advance

Frame advance lets you view one stop-action frame after another in forward sequence. Frame advance works best for tapes recorded in the SP or SLP speed.

1. Press PAUSE during playback to stop the action.
2. Press F.ADV each time you want to view a frame of the scene.
3. Press PAUSE or PLAY to resume normal playback.

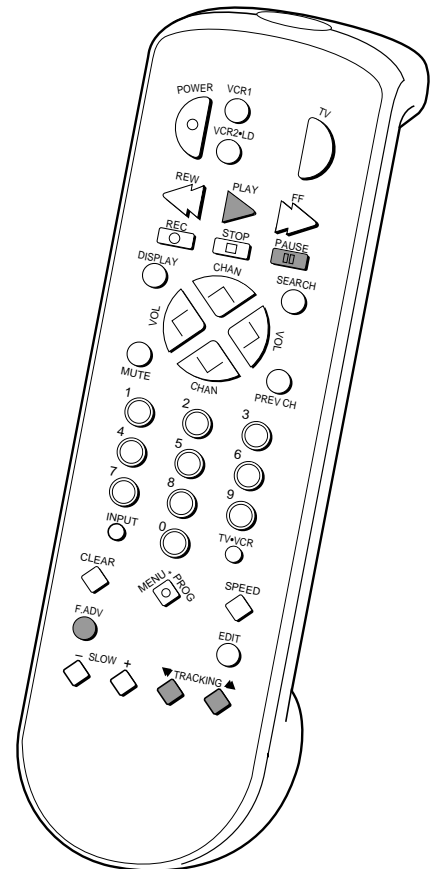

Using the Playback Features

Slow Motion

You can view the picture in forward slow motion during play or play pause. SLOW up and down allow you to change the speed. Sound is turned off during slow-motion playback. Slow motion works best in the SP or SLP speed.

1. During playback, press SLOW – or + to start slow-motion playback.
SLOW+ appears in the VCR's display panel.
2. Press SLOW + to increase the speed or – to decrease the speed.
3. Use TRACKING up or down to remove any streaks from the picture.
4. Press PLAY to return to playback.

The VCR will automatically switch from slow-motion playback to stop after a few minutes.

Picture Search

You can search a picture during playback by fast forwarding or rewinding the tape. Sound is turned off during picture search. The picture is best for tapes recorded in the SP or SLP speed.

Fast Forward Search

1. Press FF on the remote or FWD on the VCR to search forward at a faster-than-normal speed.
2. Press FF on the remote, FWD on the VCR, or PLAY to return to playback.

Rewind Search

1. Press REW to search in reverse at a faster-than-normal speed.
2. Press REW or PLAY to return to playback.

Digital Auto Tracking

The VCR has digital auto tracking which adjusts the picture when playing back a tape recorded on another VCR. Automatic tracking is turned on whenever a tape is inserted or the VCR's power is turned on.

Manual Tracking

Occasionally, you may need to manually adjust tracking on a tape recorded on a different VCR or camcorder. The TRACKING buttons on the remote or VCR are used when playing a tape. They have no effect during recording.

- When streaks or snow appear, press TRACKING up or down for the best possible picture.
- Press TRACKING up or down during stop-action pause to reduce picture "jitter".

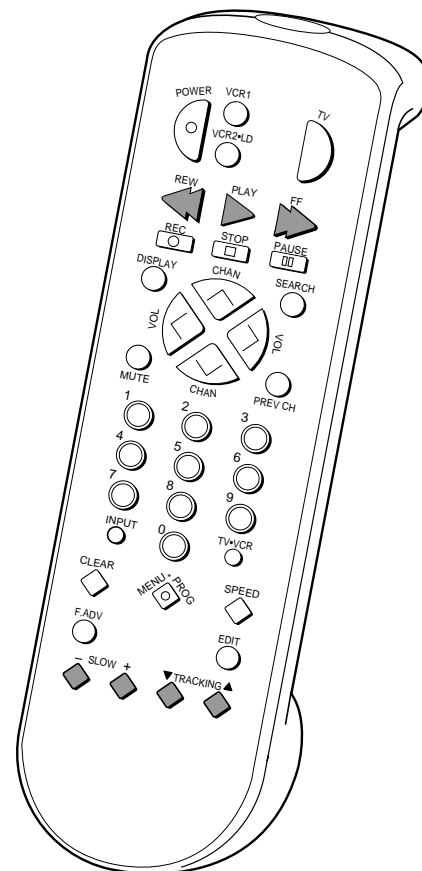

Using the Playback Features

DISPLAY Button

1. Press DISPLAY on the remote to display the status of the VCR, channel number, time counter, date, time, and tape speed on the TV screen. The time will appear in the display panel.
The time and date must be set before they are displayed. If you do not press DISPLAY again, these displays will time out.
2. Press DISPLAY again to have only the time counter remain on the TV screen. The time counter will appear instead of the time in the VCR's display panel.
3. Press DISPLAY again to remove the time counter from the TV screen.
The time counter will remain in the VCR's display panel and no status displays will appear on the TV screen. This is convenient for editing tapes.
4. Press DISPLAY again to return to the normal status displays.
Turning off the VCR automatically returns the displays to normal.

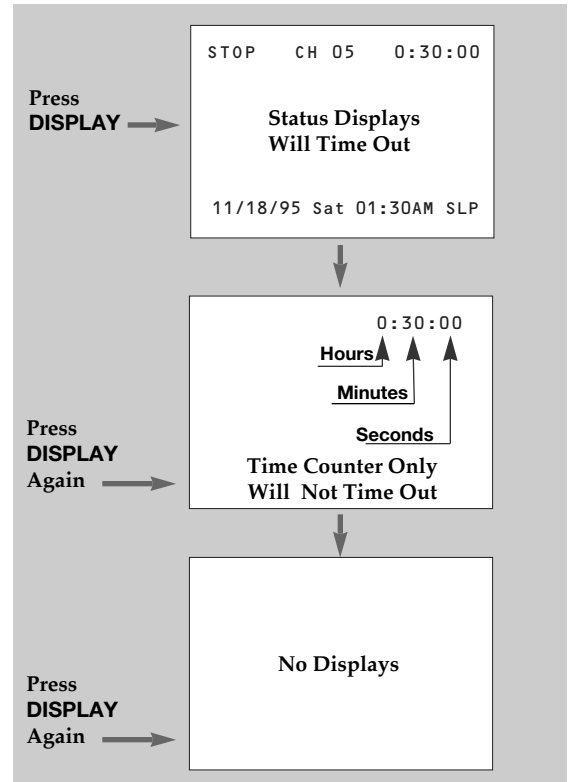

Time Counter

The time counter shows the actual time it takes to record a program or play back a segment of a prerecorded tape. It helps locate the beginning or end of programs you taped. The time counter resets to 0:00:00 whenever the tape is ejected from the VCR.

For example, if a 30-minute program was recorded at the beginning of the tape, you would:

1. Insert the prerecorded tape. Press STOP. Make sure the tape is rewound.
2. Press DISPLAY on the remote twice to display only the time counter on the TV screen.
3. Press CLEAR on the remote to reset the time counter to 0:00:00.
4. Press FF on the remote or FWD on the VCR to fast forward the tape until the time counter reads 0:30:00. Press STOP.
This is the approximate end of the program and you can begin recording at this spot.
5. Press DISPLAY twice to remove the time counter from the screen and return to the normal displays.

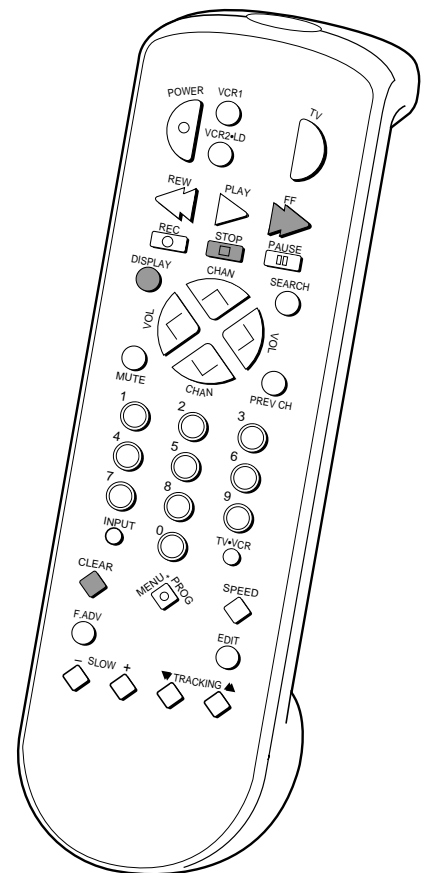

Using the Playback Features

Index Search

The VCR has a "VHS Index Search System" that automatically records an index mark on the tape every time you stop and then start a new recording. During playback you can locate the program you want to play by the number of index marks. The VCR will automatically locate the index number you select. The VCR will search forward or reverse from the location you are on the tape.

1. Insert the prerecorded tape and press STOP.
2. Press SEARCH on the remote to display the INDEX SEARCH menu on the TV screen.
3. Press two number buttons to enter the number of index marks you want the VCR to search. Press CLEAR on the remote to correct an entry.
4. Press FF on the remote or FWD on the VCR to search forward. Press REW to search in reverse.
5. Press STOP to stop index searching. Some index marks may be missed by the VCR.
 - A mark too close to your location on the tape.
 - The mark at the beginning of a recorded segment of five minutes or less.
 - The first index mark on the tape when you start at the beginning of the tape.

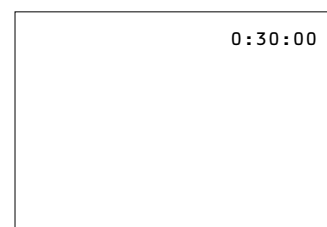
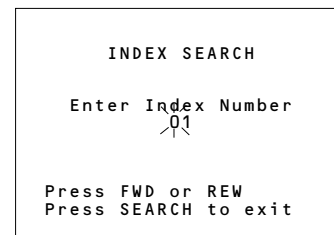

Zero Search

The zero search feature allows you to quickly return to a counter reading of 0:00:00 at any spot on the tape. This is convenient when you want to watch a segment of the tape several times.

1. Insert the prerecorded tape and press STOP.
2. Press DISPLAY twice to display only the time counter on the TV screen.
3. Locate the point on the tape that you want to return to quickly.
4. Press CLEAR to reset the time counter to 0:00:00.
5. You can continue to play the tape or perform other functions. When you are finished, press STOP.
6. Press SEARCH twice to display the ZERO SEARCH menu. The current tape counter is displayed.

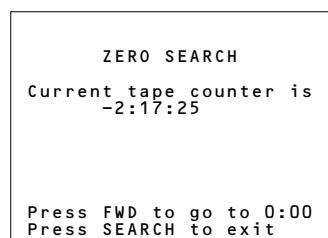
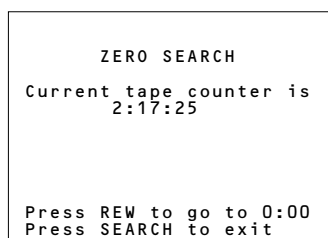

7. Press REW to return to 0:00:00. The time counter is displayed in the upper right corner of the TV screen during search.

If the time counter reading has a minus (-) in front of it, press FF on the remote or FWD on the VCR to return to a reading of 0:00:00.

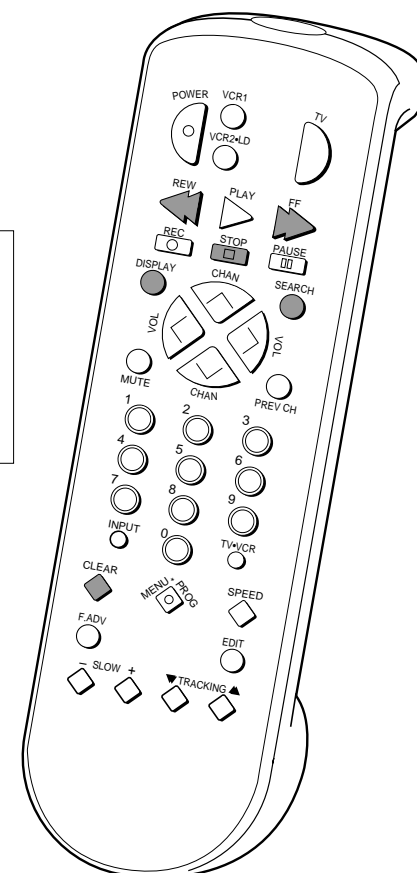

Commercial Scan

This is useful for scanning commercials or short program segments.

1. Press SEARCH once during playback to advance the tape approximately 60 seconds.
2. Press SEARCH twice during playback to advance the tape approximately 120 seconds.

Types of Recordings

Your VCR provides different types of recording. These types are explained in the following sections:

Basic Recording – Operating Instructions

Recording While You're Away

Timer Recording

One Touch Recording (OTR)

Using Two VCRs for Copying Tapes

Using the Recording Features

Recording Speeds

Press **SPEED** on the remote to select a recording speed (SP, LP, or SLP). The speed you select appears on the TV screen and in the VCR's display panel. The VCR automatically selects the playback speed (SP, LP, or SLP).

Cassette Type	Recording Time		
	SP	LP	SLP
T120	2Hr	4Hr	6Hr
T160	2Hr 40Min	5Hr 20Min	8Hr

SP (Standard Play) gives the best quality recording. That is why most prerecorded, rental tapes are recorded in SP. Fewer programs can be recorded on the tape. Special effects such as pause, slow motion, picture search, and frame advance work well in SP.

LP (Long Play) gives twice the recording time of tapes recorded in SP. Special effects in playback are not recommended in LP.

SLP (Super Long Play) gives three times the recording time of tapes recorded in SP. Special effects such as pause, slow motion, picture search, and frame advance work well in SP.

Recording Pause

This feature allows you to prevent recording short passages of unwanted material.

Press **PAUSE** during recording to stop and start recording. **REC P** appears in the VCR's display panel.

The VCR will automatically switch from pause to stop after a few minutes.

Basic Recording – Operating Instructions

To Make a Recording

Turn on the TV and tune it to the VCR viewing channel, either 3, 4, or TV's video input channel.

1. Insert a tape with safety tab in place.
The cassette-in indicator  lights in the VCR's display panel.
2. Press VCR1 (VCR2•LD) to set remote to control the VCR.
3. If using one of the basic hookups, make sure the VCR indicator appears in the VCR's display panel. If not, press TV•VCR to turn it on.
4. Select recording speed using SPEED on the remote.
The tape speed indicator appears in the VCR's display panel and on the TV screen.
5. Select the channel to be recorded.
The channel number appears in the VCR's display panel and on the TV screen.
6. Press REC on the remote or RECORD on the VCR to begin recording. REC appears in the VCR's display panel while the VCR is recording.

Watch a TV Channel While VCR is Recording a Different Channel

1. Follow steps 1 through 6 above.
2. If using one of the basic hookups, press TV•VCR to switch to the TV channel. The VCR indicator will turn off in the display panel.
3. Press TV to set the remote to control TV functions for a compatible TV.
4. Select the channel you want to watch with the TV's channel buttons.
5. Press STOP when recording is finished.

Recording While You're Away (Timer Recording)

The timer program feature lets you program the VCR to record up to eight different programs within a one year period. Before setting the timer, make sure that:

- The clock is set correctly.
- A tape with safety tab has been inserted with enough tape to record the programs.
- The remote is set to control the VCR — using VCR1 (VCR2•LD).
- If you receive all channels through a cable box (or satellite receiver), select a cable box or satellite receiver channel *on the next page*.

Setting a Timer Recording

1. Press MENU•PROG on remote to display VCR MAIN MENU.
2. Press 1 to display TIMER RECORDINGS menu.
3. Press 1 to display Create a New Program menu.
4. Press 1, 2, 3, or 4 to select type of program.
 - 1 One Time — single program recorded once.
 - 2 Daily — program recorded at same time every day.
 - 3 Weekdays — program recorded at same time Monday through Friday.
 - 4 Weekly — program recorded at same time once a week.
5. Press number buttons on the remote to enter the channel number (or INPUT on the remote to select the line input), start time including AM or PM, end time, and start date of the recording. Just follow the on-screen prompts.

Press CLEAR to correct an entry.

If you receive all channels from a cable box (or satellite receiver) and have completed CABLE BOX SETUP, the output channel of your cable box (or satellite receiver) will automatically appear on the display.
6. Select recording speed using SPEED on the remote.
7. Press MENU•PROG to enter your program. A reminder appears which will time out or you can press MENU•PROG to return to the VCR MAIN MENU.

PROGRAMS OVERLAP may appear on the screen if you have entered two programs where the times overlap.
8. The TIMER RECORDINGS menu appears. Press 1 to enter an additional timer program, or press 0 to exit.
9. **Turn off the VCR** before recording begins.

TIMER appears in the VCR's display panel when the timer has been programmed.
10. If using a cable box, leave it turned on and tuned to the channel you want to record.

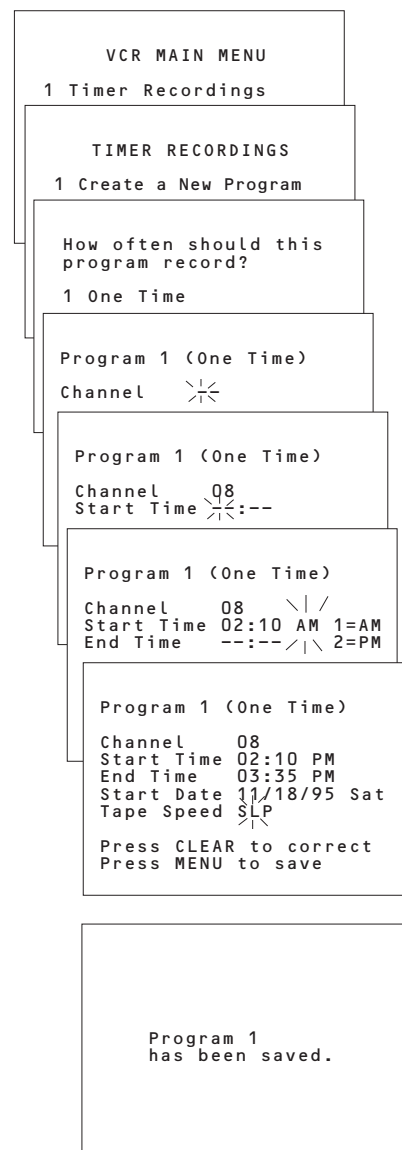

Stopping a Recording in Progress

With the VCR: Press POWER and then STOP within a few seconds.

With the Remote: Press VCR1 (VCR2•LD) and then STOP within a few seconds.

Recording While You're Away (Timer Recording)

Select Cable Box (or Satellite Receiver) Channel

If you receive all channels from a cable box (or satellite receiver) and complete Cable Box Setup, the VCR will automatically enter the output channel of your cable box (or satellite receiver) as the channel to be recorded in the TIMER RECORDINGS menu.

1. Press MENU•PROG to display the VCR MAIN MENU on the TV screen.
2. Press 3 to select CHANNELS menu.
3. Press 4 to select CABLE BOX SETUP menu.
4. **Cable box not used for all channels:** Press 2. You are finished with cable box setup.

Cable box used for all channels: Press 1 to continue .

5. Press two numbers on the remote to enter the output channel of your cable box (or satellite receiver). Press 0 before a single-digit number. Valid numbers are 01 – 99.

If you connected your cable box (or satellite receiver) to the VCR using it's AUDIO/VIDEO OUT jacks, press INPUT on the remote to select the VIDEO IN option.

Press CLEAR on the remote to correct an entry.

6. Press MENU•PROG to proceed.

A message appears showing the output channel of your cable box (or satellite receiver) that the VCR will automatically enter as the channel to be recorded in the TIMER RECORDINGS menu.

7. Press MENU•PROG to proceed.

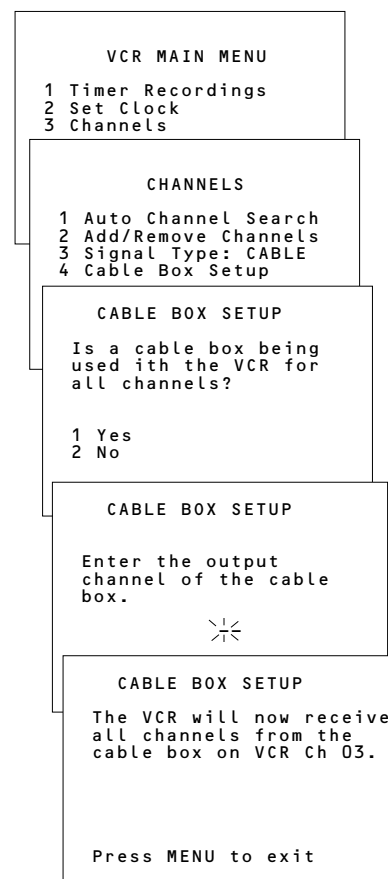

Check or Clear a Timer Recording

1. Press MENU•PROG on remote to display the VCR MAIN MENU on the TV screen.
2. Press 1 to display the TIMER RECORDINGS menu.
3. Press 2 for Review Existing Progs. feature.

The first program in the timer is displayed.

- **Check the Programs:** Press MENU•PROG to display information for the next program.
- **Clear the Program:** Press CLEAR when the program appears that you want to delete.

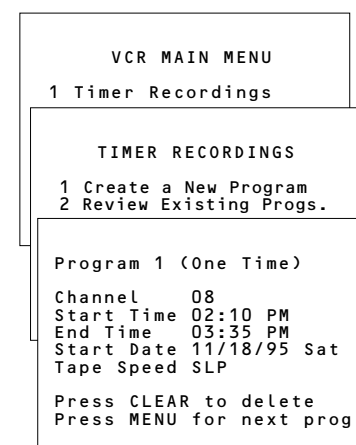

Timer Recording From the VCR's Line Input

The line input refers to the signal coming from the AUDIO and VIDEO IN jacks of the VCR. Recording from the line input is convenient if you have a satellite receiver or similar component attached to these jacks. To timer record from the component connected to the VCR's line input:

Press INPUT to enter the channel number when you program the timer. Enter VIDEO1 to record from the jacks on back of the VCR or VIDEO2 to record from the jacks on the front of the VCR.

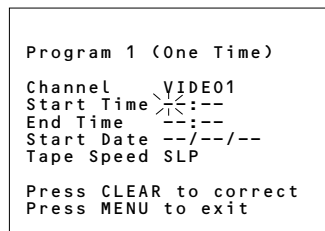

One Touch Recording

One touch recording lets you record up to four hours without using the timer program feature. The VCR will turn off automatically at the end of the recording.

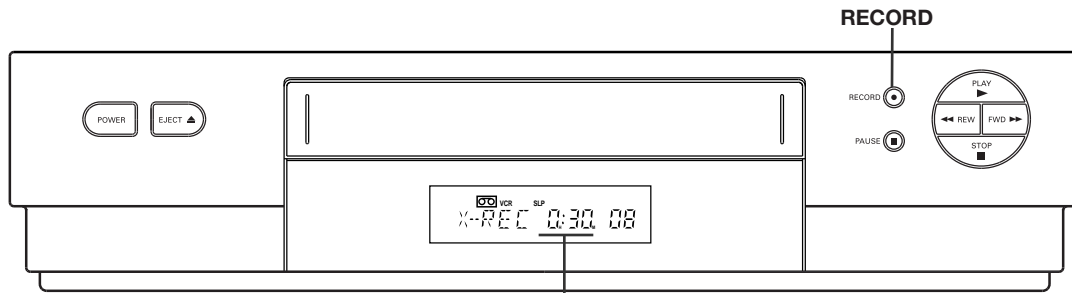

Display showing 30 minutes remaining for one touch recording.

Operating Instructions

1. Turn on the VCR.
2. Insert a tape with safety tab in place.
3. Select the channel you want to record.
4. Select the desired recording speed using SPEED on the remote.
5. Press REC on the remote or RECORD on the VCR to activate recording.
6. Press REC on the remote or RECORD on the VCR repeatedly until the amount of recording time for the program is displayed in the VCR's display panel or on the TV screen.

	Press RECORD	Recording Time
	0:30	(30 Min)
	1:00	(1 Hr)
	1:30	(1 Hr, 30 Min)
	2:00	(2 Hrs)
	3:00	(3 Hrs)
	4:00	(4 Hrs)
	0:00	(OTR Turns Off)

Each press increases the time — 30 minutes up to four hours.

The amount of time the VCR will record and X-REC will appear in the VCR's display panel.

You can increase the amount of recording time by pressing REC on the remote or RECORD on the VCR.

Stopping a Recording in Progress

With the VCR: Press POWER and then STOP within a few seconds.

With the Remote: Press VCR1 (VCR2•LD) and then STOP within a few seconds.

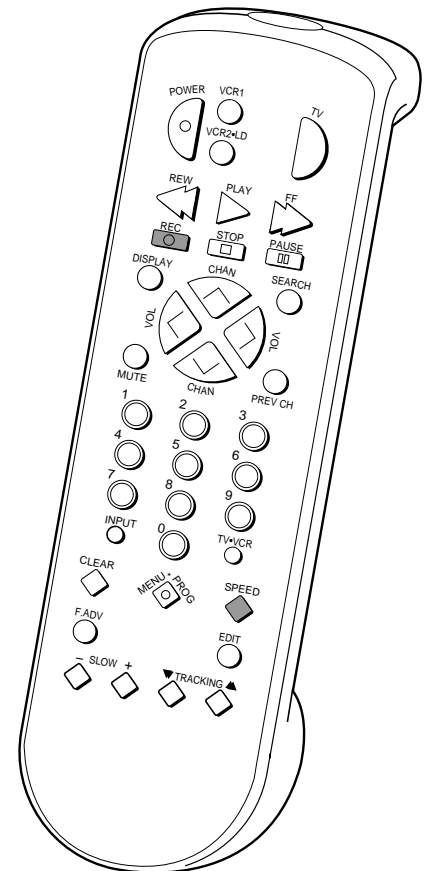

Using Two VCRs for Copying and Editing Tapes

Operating Instructions (Refer to hookup on page 6.)

Use this VCR as the playback VCR and the other VCR as the recording VCR. If you have two compatible VCRs, use the AutoEdit feature *described below*.

Caution: The unauthorized recording of television programs and other materials may infringe the rights of others.

1. Turn on the TV and VCRs.
2. Tune TV to the VCR viewing channel, either 3, 4, or TV's video input.
3. If you have connected your VCR using Option A (*page 6*), tune recording VCR to channel 3 or 4 — the one selected in the Output Channel feature in the PREFERENCES menu.

If you have connected your VCR using Option B (*page 6*), press INPUT on recording VCR to select the line input. Select L1 to record from jacks on the back of the VCR or L2 to record from jacks on the front of the VCR.

4. Insert the tape you want to copy into playback VCR. Insert a blank tape with safety tab in place into recording VCR.

To prevent recording on-screen displays from the playback VCR, press DISPLAY three times. *See page 18 for details.*

5. Press PLAY, then PAUSE on playback VCR when you reach the point on the tape or program where you want to begin copying. If the tape was not recorded on the playback VCR, streaks may appear and you may need to adjust tracking.
6. Press RECORD, then PAUSE, on the recording VCR.
7. Press PAUSE buttons on both VCRs at the same time to begin copying the tape.*
8. Edit out segments that you do not want to copy by pressing PAUSE on recording VCR to stop copying the tape. Then locate the next segment you want to copy on the playback VCR by using FWD, REW, and PLAY. Press PAUSE on the playback VCR. Press PAUSE **at the same time** on both VCRs to resume copying.
9. Press STOP on both VCRs when you are finished.

* You may turn off the TV after the recording has started as it does not have to be on to copy a tape.

Using Dual Remote with AutoEdit™

Use this VCR as the playback VCR and set it to respond to VCR2•LD on the remote *as described on page 11*.

Use your other compatible VCR as the recording VCR, which should respond to VCR1.

1. Follow steps 1 – 4 in the “Operating Instructions” above.
2. Press VCR1 on remote to control recording VCR. Press REC on the remote, then PAUSE, to put recording VCR in pause mode.
3. Press VCR2•LD on remote to control playback VCR.
4. Use FF, REW, and PLAY to locate the point where you want to begin copying. Press PAUSE while VCR is playing to put playback VCR in pause mode.
5. Press EDIT on remote to start the VCRs copying.
6. Press EDIT again when you want to stop the tape from copying.
7. Repeat steps 4 – 6 as needed.
8. Press VCR1, STOP, then VCR2•LD, STOP, when you are finished.

Location of Controls

Front Panel

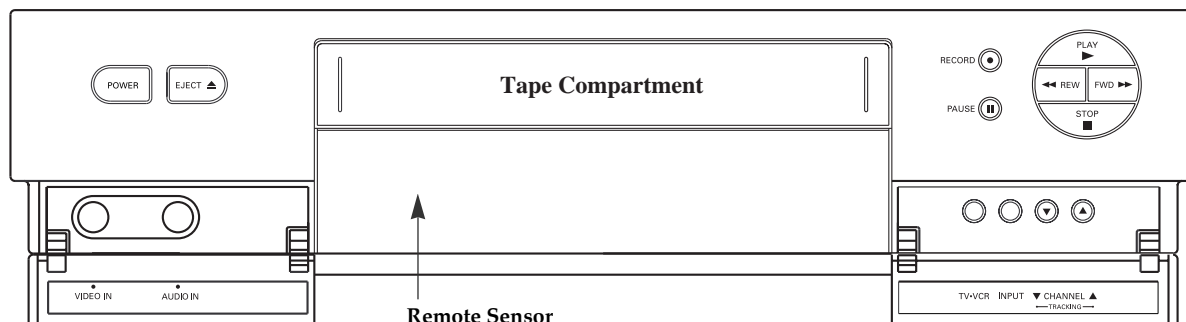

CHANNEL/TRACKING (Up or Down)

Selects next higher or lower channel in the VCR's channel memory.

Adjusts tracking when a tape is playing.

EJECT

Press when the VCR is stopped to eject the cassette.

FWD (Fast Forward)

Fast forwards the tape when the VCR is stopped.

Searches the picture forward during playback.

INPUT

Turns the line input on or off. L1 or L2 appears in VCR's display panel and VIDEO1 or VIDEO2 appears on the TV screen.

Line input refers to the signal coming from the component connected to the audio/video input jacks on the back (L1) of the VCR or front (L2) of the VCR.

PAUSE

Pauses action for viewing during playback.

Pauses recording to prevent recording of unwanted scenes.

PLAY

Plays a tape.

POWER

Turns the VCR on or off.

RECORD

Starts VCR recording.

Used for one touch recording.

Remote Sensor

Receives signals from the remote control.

Aim the remote at this sensor with no objects between them.

REW

Rewinds the tape when the VCR is stopped.

Searches the picture in reverse during playback.

STOP

Stops the normal functions such as record, playback, rewind, fast forward, or pause.

TV•VCR

Switches the picture signal so that it either comes from the VCR or the TV channel.

See page 10.

VIDEO and AUDIO IN Jacks

Receives signals from another component, like a VCR or camcorder, when it is connected to these jacks.

Use INPUT to select L2 in the VCR's display panel to record from these jacks.

Location of Controls

Back Panel

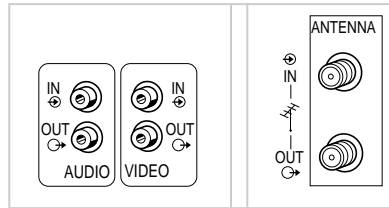

ANTENNA IN Connector

Receives the signal from an antenna or cable system that is attached to this connector.

ANTENNA OUT Connector

Passes signal to TV using the coaxial cable supplied.

VIDEO and AUDIO IN Jacks

Receives signals from another component, like a VCR or camcorder, when it is connected to these jacks. Use INPUT to select L1 in the VCR's display panel to record from these jacks.

VIDEO and AUDIO OUT Jacks

Sends signals from VCR to another component, like a TV monitor or VCR, when it is connected to these jacks.

Display Panel

This VCR has a feature that allows you to change the brightness level of the fluorescent display panel.

1. Press MENU•PROG on the remote to see the VCR MAIN MENU on the TV screen.
2. Press 4 to display the PREFERENCES menu.
3. Press 2 to select Front Panel: AUTO, BRIGHT, or DIM.
 - Select AUTO to keep the display panel bright when VCR is on and dim when it is off.
 - Select BRIGHT to keep the display panel bright.
 - Select DIM to keep the display panel dim.

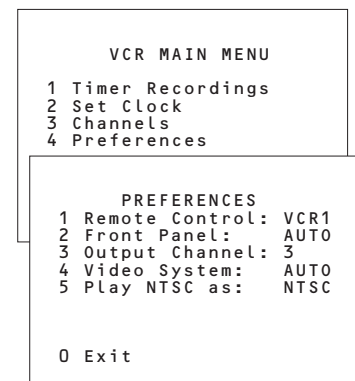

Location of Controls

Display Panel

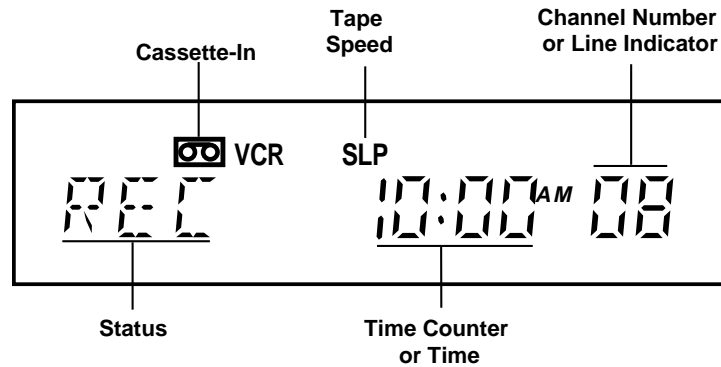

Cassette-In Indicator ()

Lights when a tape is in the VCR.

Channel Number, L1, or L2

The channel number or line indicator (L1 or L2) is displayed.

Select L1 to record from the jacks on the back of the VCR or L2 to record from the jacks on the front of the VCR.

Status Indicators

Show what the VCR is doing.

EJECT	Ejecting Tape
FFWD	Fast forward
HELLO	Turned on
PLAY	Playback
REC	Record
REC P	Record pause
REW	Rewind
SRCH +	Forward search
SRCH -	Reverse search
SLOW +	Slow motion

STILL	Frame advance
STILL	Play pause
STOP	VCR stopped
TAPE flashes	Set for timer – no tape
TIMER	Timer recording set
X-REC	One touch recording in progress

Tape Speed Indicators (SP, LP, or SLP)

Press SPEED on the remote to change.

Time or Time Counter

Press DISPLAY on the remote to switch between the current time and elapsed-time counter.

VCR Indicator (Applies Only to Basic Hookups)

Press TV•VCR to turn on or off.

VCR indicator on: Picture from VCR.

VCR indicator off: Picture from TV channel.

Specifications

Format:	VHS
Record/Playback System:	Video: 4-Head Audio: 2 Mono record/playback system
Video Signal System:	PAL M and NTSC Recording and Playback
Antenna:	75-ohm external VHF/UHF combined antenna terminal
Tuner:	USA: 181 channels capability* (125 cable channels)
Type:	AutoProgramming frequency synthesis
Power Requirement:	100-240-V AC (+/- 10%), 50-60 Hz
Power Consumption:	18 watts (6 watts in standby mode)
Dimensions:	3.5 inches high (90 mm) 15.43 inches wide (392 mm) 12.1 inches deep (309.5 mm)
Weight:	9.46 pounds (4.3 kg)
Other:	Automatic Head Cleaner 30 - Minute Memory Backup
Storage Temperature Range:	- 22°F to +149°F
Operating Temperature Range:	+41°F to +104°F

*Check your cable company's compatibility requirements.

Cleaning the VCR

Use a soft, dry, and clean cloth or dusting attachment of your vacuum cleaner to dust your VCR. Remove dust from the ventilation holes on the top, back, sides, and bottom of the cabinet.

Plastic surfaces are easily scratched and can be marred by alcohol and various solvents. Do not use any scouring agents, solvents, or abrasive products. Avoid excessive use of oil-based furniture polishes since the materials used in the cabinet will accumulate more dust. We recommend using a non-abrasive, anti-static cleaner and polisher.

If an object or liquid penetrates the VCR, unplug it immediately and have it checked by an authorized technician.

Trouble Checks

Sometimes problems can be easily solved by checking a few basic things. Check below before you call for help or take your VCR to an Authorized GE VCR Service Center.

Trouble	Here's what to try:
No power	<ul style="list-style-type: none"> • Plug VCR into an operating outlet. • Check connections.
Clock shows incorrect time or date	<ul style="list-style-type: none"> • Power interruption. Clock area in display panel will show - :- -. • Clock was not set accurately (check AM/PM and date). • Time counter display appears in display panel. Press DISPLAY on remote.
Remote locks up	<ul style="list-style-type: none"> • Remove batteries and hold down one or more buttons for several seconds to drain the microprocessor inside the remote to reset it. Reinstall the batteries and try remote again.
VCR does not respond to remote	<ul style="list-style-type: none"> • Press VCR1 (VCR2•LD) to set remote to control the VCR. <i>See page 11.</i> • Aim remote at VCR with no objects between them. • Change batteries.
Remote no longer controls a GE TV	<ul style="list-style-type: none"> • Press TV to set remote to control the corresponding compatible TV. <i>See page 14.</i> • Reprogram remote for GE TV. <i>See page 14.</i> • Aim remote at TV with no objects between them. • Change batteries.
Remote no longer controls a compatible TV, other than GE	<ul style="list-style-type: none"> • Press TV to set remote to control a compatible TV. <i>See page 14.</i> • Aim remote at component with no objects between them. • Reprogram remote after batteries have been changed. • Change batteries.
VCR only responds to VCR2•LD button on remote	<ul style="list-style-type: none"> • Check setting of Remote Control: VCR1/VCR2 feature. <i>See page 11.</i>
No picture when VCR turned on – using a basic hookup	<ul style="list-style-type: none"> • Press TV•VCR to turn VCR indicator on. <i>See page 10.</i> • Check TV channel selected (3 or 4) to make sure it matches the channel selected with the Output Channel feature. <i>See page 8.</i>
Poor or no picture for normal TV viewing	<ul style="list-style-type: none"> • Press TV•VCR to turn VCR indicator off. • Switch TV to an active channel. • Check antenna connections.
Snowy or no picture during playback	<ul style="list-style-type: none"> • Press TV•VCR to turn VCR indicator on. • Check TV channel selected (3 or 4) to make sure it matches the channel selected with the Output Channel feature. <i>See page 8.</i> • Check TV's fine tuning. • Check video cable connections between VCR and TV monitor. • Set TV monitor to video input channel. • Try another tape. • Some snow/streaks are normal during search, frame advance, slow-motion, or stop-action playback. • If tape is recorded in NTSC, make sure Play NTSC as: NTSC or PAL feature is set correctly. <i>See page 15.</i>
No color picture	<ul style="list-style-type: none"> • If PLAY/NTSC is not set correctly, the VCR may play a black and white picture.

Trouble	Here's what to try:
Time counter not working	<ul style="list-style-type: none"> • The time counter does not advance during unrecorded portions of tape. When an unrecorded segment of tape is encountered, the time counter will hold its count until recorded material is detected again. • A minus (-) will appear in front of the time if you rewind the tape farther back than a counter reading of 0:00:00.
Will not record or play	<ul style="list-style-type: none"> • No cassette in VCR. • Eject and re-insert cassette. • Broken tape — try another cassette.
Streaks in picture during normal playback	<ul style="list-style-type: none"> • Some snow / streaks are normal during search, frame advance, slow-motion, or stop-action playback.
Will not record	<ul style="list-style-type: none"> • VCR is in pause mode. Press PAUSE. • Safety tab removed from cassette. • Make sure the line indicators (L1 and L2) are turned off in VCR's display panel for normal recording from the VCR's tuner. Press INPUT to turn off the line indicator.
Rewind does not operate	<ul style="list-style-type: none"> • Tape already rewound.
Timer recording not made or wrong program recorded	<ul style="list-style-type: none"> • Program entered incorrectly (wrong channel or times). • Power interruption. Clock area in display panel will show - :- -. • Check to see if time and date are correct — including AM/PM. • Program exceeded tape's length or tape was not rewound beforehand. • VCR was not turned off at the time recording was to start. • No tape in VCR or cassette's safety tab broken off. • Cable box not turned on at time recording was to begin.
VCR makes noise when stopped	<ul style="list-style-type: none"> • VCR is removing tape from heads. This is normal. The head cylinder inside the VCR will continue to rotate for a few minutes after you put the VCR in the stop mode.
Will not auto search active channels correctly	<ul style="list-style-type: none"> • Check antenna connections. • Check Signal Type: CABLE/ANTENNA feature. <i>See page 9.</i>
Cannot select channels over 69	<ul style="list-style-type: none"> • Cable channels over 69 can only be selected if Signal Type: CABLE/ANTENNA feature is set to CABLE. <i>Details are on page 9.</i>

Index

- Accessories, Included7
- Add or Remove Channels from Memory9
- ADD/REMOVE CHANNELS Menu9
- Antenna Connections2,3
- ANTENNA IN Connector3-6,27
- ANTENNA OUT Connector3-6,27
- Attaching Power Cord7
- AUDIO and VIDEO IN Jacks6,23,25,26,27
- AUDIO and VIDEO OUT Jacks3-6,23,25,27
- Auto Channel Search Feature9
- Auto Head Cleaner16
- AutoEdit25
- Back Panel Controls27
- Basic Recording21
- Batteries, Inserting in Remote7
- Buttons
 - Components12
 - TV13
 - VCR12-13
- Cable Box Channel, Selecting23
- Cable System With Cable Box
 - Connections2,4-5
- Cable System Without Cable Box
 - Connections2,3
- CABLE BOX SETUP Menu23
- Cassette, Inserting15
- Cassette-In Indicator15,21,28
- CHAN and CHANNEL Up or Down
 - Buttons10,12-13,26
- Channel Number Indicator28
- CHANNELS Menu9,23
- Checking Timer Programs23
- Checks, Trouble30-31
- Choosing a Hookup2
- Cleaning the VCR29
- CLEAR Button10,12-13,18,19,22-23
- Clearing Timer Programs23
- Commercial Scan19
- Connections
 - Antenna2-3
 - Audio/Video Jacks2,3-6
 - Cable TV2,3-5
 - Two VCRs6
- Contents1
- Controlling
 - TV14
 - VCR11
- Copying and Editing Tapes25
- Copying Tape, Connections2,6
- Date, Set10
- Design Specifications29
- Digital Auto Tracking17
- DISPLAY Button12-13,18,28
- Display Panel27-28
- Displays, Status18,28
- EDIT Button25
- Editing and Copying Tapes25
- EJECT Button15,26
- Escoge una Lengua8
- F.ADV (Frame Advance) Button12,16
- Fast Forward Search17
- FF and FWD (Fast Forward)
 - Buttons12,17,18,19,25,26
- First-Time Operation7-10
- Frame Advance16
- Front Panel26
- Front Panel: AUTO/BRIGHT/DIM Feature27
- Head Cleaner, Auto16
- Hookups
 - Antenna2-3
 - Audio/Video Jacks2,3-6
 - Cable TV2,3-5
 - Two VCRs6
- Index Feature19
- INDEX SEARCH Menu19
- Indicators in Display Panel28
- Indicators, Status28
- INPUT Button12,23,25,26,27
- Inserting a Cassette15
- L1 and L2 Indicators12,25,26,27,28
- LANGUAGE Menu8
- Language, Select8
- Line Input, Recording From23
- Location of Controls
 - Remote Control12-13
 - VCR Back Panel27
 - VCR Display Panel27-28
 - VCR Front Panel26
- LP Speed20
- Manual Tracking17
- MENU•PROG Button8,9,12,22-23
- MUTE Button13
- NTSC Video Playback Mode15
- NTSC Video System8,15
- Number Buttons8-11,12-13,14,15,19,22-23
- On-Screen Displays18
- One Touch Recording24
- One Touch recording, Stopping24
- Operation, First Time7-10
- OTR (One Touch Recording)24
- Output Channel, Selecting8
- PAL Video System8,15
- Panel Display Feature27
- PAUSE Button12,16,20,25,26
- Pause for Stop Action16
- Pause, Recording20
- Picture Search17
- PLAY Button13,15,16,17,25,26
- Playing a Tape15
- POWER Button11,12-13,14,22,24,26
- Power Cord, Attaching7
- PREFERENCES Menu8,9,11,15,27

Index

- PREV CH (Previous Channel) Button 13
- Problems, Solving 30-31
- Programming Remote to Control
 Compatible TV 14
- Programming Remote to Control VCR 11
- PROGRAMS OVERLAP Message 22
- REC and RECORD Buttons 13,21,24,25,26
- REC Indicator 21,28
- REC P (Record Pause) Indicator 20,28
- Recording
 Basic 21
- Features 20
- From Another VCR 25
- One Program While Watching Another 21
- One Touch (OTR) 24
- Pause 20
- Speeds 20
- Timer 22-23
- Recording While You're Away
 (Timer Recording) 22
- Remote Control 11-14
- Remote Control: VCR1/VCR2 Feature 11
- Remote Function Buttons 12-13
- Remote Sensor 26
- Remove or Add Channels from Memory 9
- REMOVE/ADD CHANNELS Menu 9
- REW (Rewind) Button 13,15,17,19,25
- Safety Precautions Inside Front Cover
- Safety Tab 15
- Satellite Receiver Channel, Selecting 23
- SEARCH Button 13,19
- Search, Fast Forward 17
- Search, Rewind 17
- Seleccione o Idioma 8
- Select an Output Channel 8
- Select Cable Box or Satellite Receiver
 Channel 23
- Select the Language 8
- Selecting a Video System 8
- Sensor, Remote 26
- SET CLOCK Menu 10
- Set the Time and Date 10
- Setting a Timer Recording 22
- Setting Up the VCR 7-10
- Signal Type: CABLE/ANTENNA Feature 9
- SLOW + and - Buttons 13,17
- Slow Motion 17
- SLOW+ Indicator 17,28
- SLP Speed 20
- Solving Problems 30-31
- SP Speed 20
- Specifications 29
- SPEED Button 13,20,21,24,28
- Speeds, Recording 20
- Startup 7-10
- Status Displays 18,28
- STILL Indicator 16,28
- Stop Action Pause 16
- STOP Button 13,15,18,19,21,22,23,24,25,26
- Stopping a Timer Recording 22
- Stopping an Express Recording 24
- Tab, Safety 15
- Table of Contents 1
- Tape Speed Indicators 20,28
- Tape, Playing 15
- Time and Date, Set 10
- Time Counter 18,19,28
- Time Display 28
- Time, Setting 10
- TIMER Indicator 22,28
- Timer Recording 22
- TIMER RECORDINGS Menu 22-23
- TRACKING Buttons 13,15,16,17,26
- Tracking, Digital Auto and Manual 17
- Trouble Checks 30-31
- Turn On TV 7
- Turn on VCR 8
- TV Button 12,14
- TV Control with Remote 14
- TV Function Buttons 13
- TV, Controlling with Remote 12-13,14
- TV, Turn On 7
- TVs, Compatible Chart 14
- TV•VCR Button 10,13,21,26
- Types of Recordings 20
- VCR Controls 26-28
- VCR Function Buttons 12-13
- VCR Indicator 10,15,21,28
- VCR MAIN MENU 8,9,11,15,22-23,27
- VCR, Cleaning 29
- VCR, Controlling with Remote 11,12-13
- VCR, Turn On 8
- VCR1 and VCR2•LD
 Buttons 8,9,10,11,12,14,21,22,24,25
- VCR1/VCR2 Feature 11
- VCRs Memory, Placing Channels In 9
- VCRs, Connecting for Tape Copying 2,6
- Video Playback Mode for NTSC Recordings 15
- Video System, Selecting 8
- VIDEO1 and VIDEO2 Indicators 23,26
- VOL Up or Down Button 13
- Warnings Inside Front Cover
- Watch One Channel While
 Recording Another 21
- X-REC Display 24,28
- Zero Search Feature 19
- ZERO SEARCH Menu 19

Please do not send any products to the Indianapolis address listed in this manual or on the carton. This will only add delays in service for your product.

 **THOMSON CONSUMER ELECTRONICS**

10330 North Meridian Street
Indianapolis, IN 46290-1024 USA

©1995 Thomson Consumer Electronics, Inc.
Trademark(s)® Registered
Marca(s) Registrada(s)
Printed in Singapore
Part Number 95-VGM300-1